



Russell Hobbs

INSTRUCTIONS AND WARRANTY



MODEL NO. RHFP66

RUSSELL HOBBS INFINITY FOOD PROCESSOR

Congratulations on purchasing our Russell Hobbs Infinity Food Processor. Each unit has been manufactured to ensure safety, reliability and ease of use. Before use, please read the instructions carefully and keep it for future reference. Should you pass the unit on, please ensure that you also pass the instruction manual on.

FEATURES OF THE RUSSELL HOBBS INFINITY FOOD PROCESSOR

- Bringing versatility, efficiency and effortless food preparation to your kitchen
- 500W
- 2 speed control plus pulse for precise start and stop control
- The Food Processor includes the following accessories:
 - plastic 1.4L food processing bowl
 - stainless steel slicing/chopping/mixing blade
 - stainless steel slicing blade
 - stainless steel shredding disc
 - stainless steel chip slicing disc
 - dough tool
 - citrus juicing attachment
- Chop, shred, slice, juice and mix various ingredients all in one unit
- Double safety lock system
- Non-slip rubber feet for stability
- For domestic use only
- 2 year warranty (1 year retail • 1 year extended upon online registration of product • visit www.russellhobbs.co.za)

IMPORTANT SAFEGUARDS

When using any electrical appliance, basic safety precautions should always be followed including the following:

1. Please read the instructions carefully before using any appliance.
2. Always ensure that the voltage on the rating label corresponds to the mains voltage in your home.
3. Incorrect operation and improper use can damage the food processor and cause injury to the user.

4. This food processor is intended for household use only. Commercial use invalidates the warranty and the supplier can not be held responsible for injury or damage caused when using the appliance for any other purpose than that intended.
5. Avoid any contact with moving parts.
6. This food processor is not intended for use by persons (including children) with reduced physical, sensory or mental capabilities, or lack of experience and knowledge, unless they have been given supervision or instruction concerning use of the appliance by a person responsible for their safety.
7. Children should be supervised to ensure that they do not play with the food processor.
8. Check the power cord and plug regularly for any damage. If the cord or the plug is damaged, it must be replaced by the manufacturer or a qualified person in order to avoid an electrical hazard.
9. Do not use the food processor if it has been dropped or damaged in any way. In case of damage, take the unit in for examination and/or repair by an authorised service agent.
10. To reduce the risk of electric shock, do not immerse or expose the motor assembly, plug or the power cord to water or any other liquid.
11. Never immerse the unit in water or any other liquid for cleaning purposes.
12. Remove the plug from the socket by gripping the plug. Do not pull on the cord to disconnect the appliance from the mains. Always unplug the unit when not in use, before cleaning or when adding/removing parts.
13. The use of accessory attachments that are not recommended or supplied by the manufacturer may result in injuries, fire or electric shock.
14. Care must be taken when dismantling and assembling the food processor as the blades and discs are very sharp.
15. Never reach with your fingers into the feed chute.
16. Never place hard or foreign objects into the processor, the blades could become blunt. This process may also result in injury.
17. The lid should only be removed when the unit is switched off and unplugged.
18. Do not fill the processing bowl with hot liquids (only cold or warm liquids).
19. The appliance can be used for up to 1 minute without stopping (this is one cycle). Ensure the appliance is cooled down for at least 10 minutes after each cycle.

20. This food processor incorporates a protective device against high temperatures. If the temperature becomes too high and the above step has not been actioned, the unit will turn off automatically and will resume operation when the motor has cooled sufficiently (after about 15 minutes).
21. Always remove the blades/discs and blade adaptor before removing the contents of the bowl.
22. Do not exceed the maximum filling volume.
23. Please be careful with the stainless-steel blades as they are extremely sharp and store inside the processor bowl after use.
24. A short cord is provided to reduce the hazards resulting from becoming entangled in or tripping over a longer cord.
25. Do not let the cord hang over the edge of a table or counter. Ensure that the cord is not in a position where it can be pulled on inadvertently.
26. Do not allow the cord to touch hot surfaces and do not place on or near a hot gas or electric burner or in a heated oven.
27. Do not use the food processor on a gas or electric cooking top or over or near an open flame.
28. Use of an extension cord with this appliance is not recommended. However, if it is necessary to use an extension lead, ensure that the lead is suited to the power consumption of the appliance to avoid overheating of the extension cord, appliance or plug point. Do not place the extension cord in a position where it can be pulled on by children or animals or tripped over.
29. This food processor is not suitable for outdoor use. Do not use this appliance for anything other than its intended use.
30. DO NOT carry the food processor by the power cord.
31. Do not leave this food processor unattended during use. Always unplug the unit when not in use or before cleaning.
32. Always operate the appliance on a smooth, even, stable surface. Do not place the unit on a hot surface.
33. Ensure that the switch is in the "Off" position after each use.
34. The manufacturer does not accept responsibility for any damage or injury caused by improper or incorrect use, or for repairs carried out by unauthorised personnel.

35. In case of technical problems, switch off the machine and do not attempt to repair it yourself. Return the appliance to an authorised service facility for examination, adjustment or repair. Always insist on the use of original spare parts. Failure to comply with the above-mentioned pre-cautions and instructions, could affect the safe operation of this machine.
36. The appliance is fitted with a safety switch to prevent the motor operating unless the food processor bowl is in place. Do not use this to switch the appliance on and off.
37. Do not use the appliance without first locking the lid in place.
38. Do not put your hand into the bowl, even when it has been removed for cleaning – the blades are very sharp.
39. Do not put any other object (spoon, spatula, etc.) into the bowl while the processor is plugged in.
40. Do not let the bowl overflow. If liquids get under the motor unit, it may be sucked into the motor, damaging it.
41. Do not fill the bowl above the MAX. mark. If you do, the contents may force the lid off when you start the motor.
42. Do not use the appliance for any purpose other than those described in these instructions.
43. Do not run the appliance empty, as it may overheat.
44. This appliance is designed for processing household quantities; it is not suitable for commercial purposes. Use the appliance only for the purpose it was designed for.
45. Do not run this appliance with an external timer or remote control system.
46. To avoid the danger of fire and/or explosion, do not use this appliance to stir/mix paints or solvents.

Please note: the processor will only operate once the lid cover is fitted correctly and locked into place.

PARTS DIAGRAM

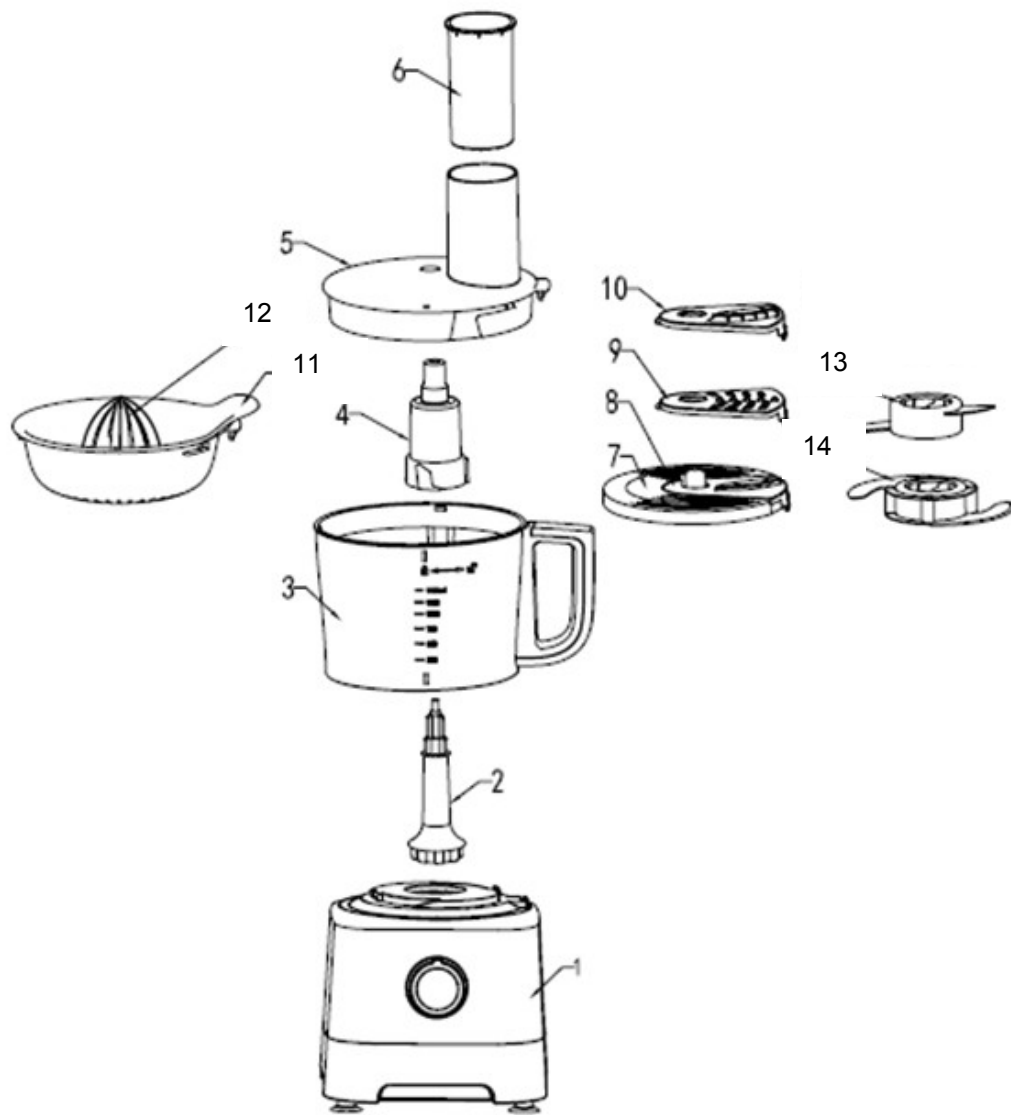

- | | |
|-------------------------|-----------------------------------|
| 1. Motor Base | 2. Removable drive attachment |
| 3. Processing Bowl | 4. Blade Adapter |
| 5. Bowl Cover | 6. Safety Pusher |
| 7. Disc Holder | 8. Slicing Disc |
| 9. Shredder Disc | 10. French Fry Disc |
| 11. Citrus Juicer Plate | 12. Citrus Juicer Head |
| 13. Dough tool | 14. Slicing/chopping/mixing blade |

BEFORE FIRST USE

Before using your appliance for the first time, remove the appliance from the box and take off any protective wrappings.

REMEMBER: DO NOT LEAVE PROTECTIVE PACKAGING LYING AROUND, AS IT COULD BE DANGEROUS AROUND INFANTS.

OPERATING INSTRUCTIONS

Locking the bowl

Align the base and bowl as illustrated above. Turn the bowl clockwise until it locks into place.

NOTE: The food processor will not work unless the bowl is locked into position.

Assembling the lid

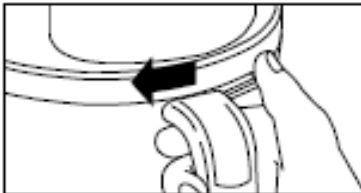

Align the lid as illustrated by placing your thumb on the lid tab and twisting the lid clockwise. NOTE: The food processor will not work unless the lid is locked into position.

Operating the controls

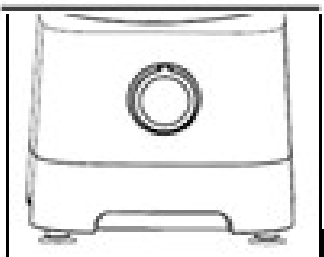

The control dial is conveniently located on the front of the base. Rotate the dial clockwise to increase the speed (2 speeds). For more precise start/stop control, turn the dial anti-clockwise to the (P) PULSE setting. To turn off the machine, rotate the dial to the OFF (0) position.

Processing using the stainless steel slicing/chopping/mixing blade

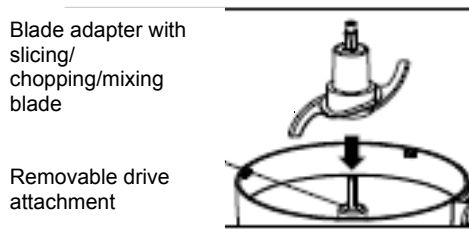

1. For a more even consistency, start with pieces of food that are similar in size. For example, do not process 10cm pieces together with 1cm pieces.
2. The stainless steel slicing/chopping/mixing blade can be used to coarsely chop, finely mince, mix, or puree food to a smooth consistency.
3. Make sure the control dial is turned to OFF (O) and the unit is unplugged.
4. Place the removable drive attachment onto the motor base.
5. Lock the food processor bowl onto the motor base (see “Locking the bowl”).
6. Place the blade adapter with the chopping blade inserted onto it into the food processor bowl.
7. Place the bowl cover onto the food processing bowl and ensure it’s locked into position.
8. Plug in the appliance and switch it on to process the food.
9. Process the food by pushing it through the feed chute with the safety pusher.
10. When finished with processing the food, turn the dial to the OFF (0) position or release from the PULSE position. Wait until the blade has stopped rotating before removing the bowl cover.
11. Unplug the appliance.

Processing using the dough tool

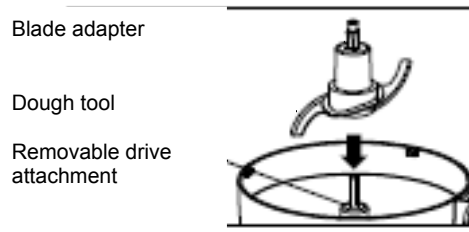

1. Make sure the control dial is turned to OFF (O) and the unit is unplugged.
2. Place the removable drive attachment onto the motor base.
3. Lock the food processor bowl onto the motor base (see “Locking the bowl”).
4. Place the blade adapter with the dough tool inserted into the food processor bowl.
5. Place the bowl cover on the food processing blade and ensure it’s locked into position.
6. Plug in the appliance and switch it on to mix the food.
7. Mix the ingredients by pushing it through the feed chute with the safety pusher.
8. When finished with mixing, turn the dial to the OFF (O) position or release from the PULSE position. Wait until the dough tool has stopped rotating before removing the bowl cover.
9. Unplug the appliance.

Processing using the stainless steel slicing, shredding and chip slicing disc

Slicer/
shredder/ chip
slicing disc

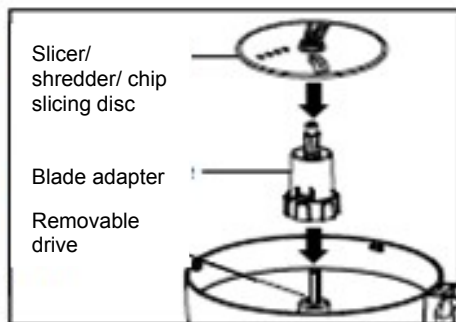

1. Make sure the control dial is turned to OFF (O) and the unit is unplugged.
2. Place the removable drive attachment on the motor shaft.
3. Lock the bowl onto the base.

4. Place the blade adapter onto the removable drive attachment, put the slicing/shredding/chip slicing disc on the blade adapter attachment with the desired side facing up for either slicing or shredding. Lock lid onto bowl (See “Assembling the lid”).
5. Plug in the appliance and switch it on to start processing the food.
6. Process the food by pushing it through the feed chute with the safety pusher.

Processing tips and techniques

1. This food processor is excellent for slicing, shredding and juicing most ingredients. However, to maintain peak performance, do not use your food processor for the following: grinding grain, coffee beans or slicing frozen meat.
2. To process the maximum capacity, use the stainless-steel slicing blade and add ingredients no higher than the maximum fill line on the plastic food processor bowl.
3. Operating time will depend on the quantity of the ingredients being processed. Most foods can be sliced or shredded in seconds.
4. To slice/shred cheese, make use of firm cheese like, Cheddar, Monterey Jack, or Swiss. Place the cheese in the freezer for 30 minutes before processing for best results.
5. Always use the safety pusher to feed food into the chute. NEVER PUSH FOOD THROUGH THE FEED CHUTE WITH HANDS, FINGERS, UTENSILS OR ANY OTHER OBJECTS.
6. Always remember to push softly when feeding food into the feed chute.
7. It's advisable to pre-cut the ingredients into smaller pieces according to the diameter of the feeding tube before processing. Feed gradually for better results.
8. When processing soft ingredients, choose the lower speed for better results. If large quantities need to be processed, rather process in several batches.

Processing using the citrus juicer

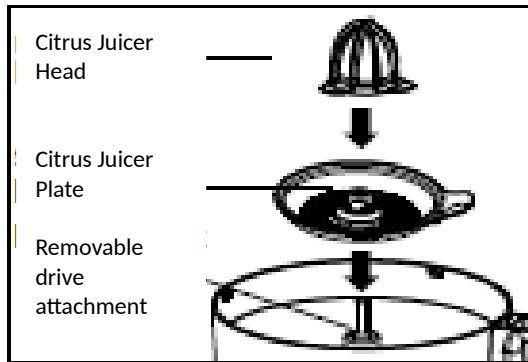

1. Make sure the control dial is turned to the OFF (O) position and the unit is unplugged.
2. Attach the removable drive attachment to the motor base.
3. Lock the plastic food processor bowl onto the base (See “Locking the bowl”).
4. Place the citrus juicer plate on the removable drive attachment, then place the citrus juicer head on the removable drive attachment on top of the citrus juicer plate.
5. The juicer head is suitable for juicing small citrus fruit, such as grapefruit, oranges, lemons, limes etc.
6. Cut the citrus fruit in half and press the cut end of the fruit half onto the cone. Turn on the machine and choose the speed. Select a low speed before juicing and gradually increase it throughout the juicing process.
7. The juicer head scrapes the pulp out and squeezes the juice from the fruit.
8. To maximize the quantity of juice extracted from a fruit, press the fruit onto the juicer head several times.

TROUBLESHOOTING GUIDE

POTENTIAL PROBLEM	PROBABLE CAUSE/SOLUTION
Unit does not function at all.	<ul style="list-style-type: none"> • Is the unit plugged in? Does the power outlet work? • Is the bowl and bowl lid all locked in place? These have safety mechanisms in place and if not attached correctly will not operate. See “Operating instructions”
Food is not sliced or shredded uniformly.	<ul style="list-style-type: none"> • Placing too much food in the feed chute or pushing too hard on the safety pusher may cause the processed food to be irregularly sliced or shredded.
Unit stops and will not switch back on.	<ul style="list-style-type: none"> • Are the bowl and bowl lid all locked in place? They may have moved slightly during processing. See “Operating instructions.” • Is the power outlet still working? Check this, by plugging in any other working appliance. You may have overloaded the circuit and blown a fuse or tripped the circuit breaker. • Turn the unit OFF, allow the appliance to rest for 15 minutes, and then turn the appliance back ON. If none of these suggestions correct the problem, DO NOT attempt to repair the unit. Call the Customer Service number to get the name of your nearest Authorized Service Centre.
Unit has a burning smell.	<ul style="list-style-type: none"> • There may be residue left on the motor from the manufacturing process, causing a slight odour during initial use. This will go away. If a strong odour or any visible smoke appears, unplug the unit IMMEDIATELY and call the Customer Service number.
Motor seems weak.	<ul style="list-style-type: none"> • Are you using the correct speed for the item you are processing? • Do the food items need to be diced into pieces before processing?

CLEANING AND MAINTENANCE

1. Wash the bowl, lid, blades, discs, blade adapter, removable drive attachment and safety pusher in warm, soapy water.
2. Rinse and dry thoroughly. **NOTE:** Do not store the unit with lid in locked position; this may put strain on the interlock tab.
3. Wipe base, control panel, and cord with a damp cloth or sponge. To remove stubborn foods, use a mild non-abrasive cleanser.
4. Place a drop of vegetable oil on the blades of the food processor on a monthly basis.

STORING THE APPLIANCE

- Unplug the unit from the wall outlet and clean all the parts as instructed above. Ensure that all parts are dry before storing.
- Store the appliance in its box or in a clean, dry place.
- Place bowl on base then place the shredding/slicing blades on the removable drive attachment. The blade adapter attachment may be stored in the bowl along with the remaining two discs. Finally place the lid on bowl but do not lock it.
- Never store the appliance while it is still dirty.
- Never wrap the power cord around the appliance.

SERVICING THE APPLIANCE

There are no user serviceable parts in this appliance. If the unit is not operating correctly, please check the following:

- You have followed the instructions correctly
- That the unit has been wired correctly and that the wall socket is switched on.
- That the mains power supply is ON.
- That the plug is firmly in the mains socket.

If the appliance still does not work after checking the above:

- Consult the retailer for possible repair or replacement. If the retailer fails to resolve the problem and you need to return the appliance, make sure that:

- The unit is packed carefully back into its original packaging.
- Proof of purchase is attached.

- A reason is provided for why it is being returned.

If the supply cord is damaged, it must be replaced by the manufacturer or an authorised service agent, in order to avoid any hazard. If service becomes necessary within the warranty period, the appliance should be returned to an approved Home of Living Brands (Pty) Ltd service centre. Servicing outside the warranty period is still available, but will, however, be chargeable.

CHANGING THE PLUG

Should the need arise to change the fitted plug, follow the instructions below.

This unit is designed to operate on the stated current only. Connecting to other power sources may damage the appliance.

WARNING: If your appliance has three wires (Green/Yellow, Blue, Brown) then it MUST be earthed. Connect a three pin plug as shown below

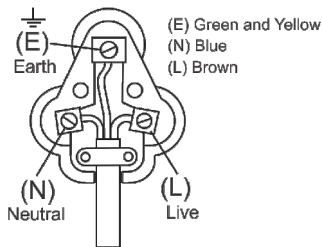

If your appliance has only two wires (Blue, Brown) then it does not need to be earthed. Connect a three pin plug as shown below

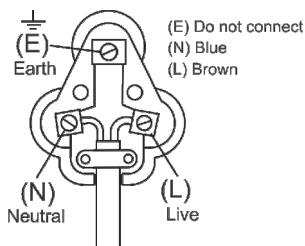

PLEASE AFFIX YOUR PROOF OF PURCHASE/RECEIPT HERE
IN THE EVENT OF A CLAIM UNDER WARRANTY THIS RECEIPT MUST BE PRODUCED.

2 YEAR WARRANTY
*1 year retail | 1 year
extended warranty upon
registration**
visit
www.russellhobbs.co.za

WARRANTY AND EXTENDED WARRANTY

1. Home of Living Brands (Pty) Limited ("Home of Living Brands") warrants to the original purchaser of this product ("the customer") that this product will be free of defects in quality and workmanship which under normal personal, family or household use and purpose may manifest within a period of 1 (one) year from the date of purchase ("warranty period").
2. Home of Living Brands shall extend the warranty period for a further period of 1(one) year ("extended warranty period"), on condition that the purchaser registers the product on the website, within 12 months from the date of purchase of the product. The website address for registration is as follows: <http://russellhobbs.co.za/info-pages/warranty-info.aspx>. The extended warranty period only applies to products purchased on or after 1 October 2017.
3. Where the customer has purchased a product and it breaks, is defective or does not work properly for the intended purpose, the customer must notify the supplier from whom the customer bought the product ("the supplier") thereof within the warranty period or if applicable, the extended warranty period. Any claim in terms of this warranty must be supported by a proof of purchase. If proof of purchase is not available, then repair, and/or service charges may be payable by the customer to the supplier.
4. The faulty product must be taken to the supplier's service centre to exercise the warranty.
5. The supplier will refund, repair or exchange the product in terms of this warranty subject to legislative requirements. This warranty shall be valid only where (a) the customer is not the cause of the product breaking, and (b) the product has been used for the intended purpose stipulated in the product manual. The warranty does not include and will not be construed to cover products damaged as a result of disaster, misuse, tamper, abuse or any unauthorised modification or repair of the product.
6. This warranty will extend only to the product provided at the date of the purchase and not to any expendables attached or installed by the customer. In this regard any accessories supplied with the product by the supplier, may be excluded in this warranty or extended warranty (see Exclusions to Warranty and Extended Warranty document).
7. If the customer requests that the supplier repairs the product and the product breaks or fails to work properly within 3 (three) months of the repair and not as a result of misuse, tampering or modification by or on behalf of the customer, then the supplier may replace the product or pay a refund to the customer, subject to the supplier's discretion.
8. The customer may be responsible for certain costs where products returned are not in the original packaging, or if the packaging is damaged. This will be deducted from any refund paid to the customer.

HOME OF LIVING BRANDS (PTY) LTD (JOHANNESBURG)

JOHANNESBURG
CAPE TOWN
DURBAN

TEL NO. (011) 490-9600
TEL NO. (021) 552-5161
TEL NO. (031) 303-1163

www.homeoflivingbrands.com
www.russellhobbs.co.za
www.facebook.com/RussellHobbsSA

EXCLUSIONS TO WARRANTY AND EXTENDED WARRANTY

1. Any accessories supplied with the product, including but not limited to, bowls, jugs, mills or carafes made either of glass or plastic and supplied with this appliance (hereinafter referred to as "the accessory or accessories"), is warranted to be free from material and workmanship defects for the duration of the appliance warranty.
2. The accessories should give trouble free service when used in accordance with the directions described in the instruction manual. However, the accessories will be damaged if subjected to impact, and this damage is not covered by the warranty. Such impact damage can occur either from the outside (if for example it is dropped or knocked against a hard surface), or from within (if for example foreign objects are placed within the accessories and the power is switched on).
3. Should you need to replace an accessory during the warranty period; a claim for a free replacement will only be considered if the item (including all shards and broken parts) is returned to the nearest HOLB service centre for examination.
4. The remains of the accessory will be carefully examined by the relevant professionals and if it is determined (at the sole discretion of HOLB) that the damage was caused by impact, then the claim will be refused and will not be covered by the warranty or any extended warranty.
5. Any replacement part provided in terms of clause 4 above will become a chargeable item payable by the customer.